

TECHIMPEX

Marine Cookers

MAXIMA

Our company houses a boutique laboratory, specializing in crafting innovative and exclusive gimbaling modules with a modern and minimalist design, tailored perfectly for today's cutting-edge vessels.

Our artisanal workshop has developed a range of high-end cookers in maxi sizes.

The modules are available with either 4 or 5 burners.

The ovens are spacious and come with powerful grills, electronic ignition, and double-pane glass doors.



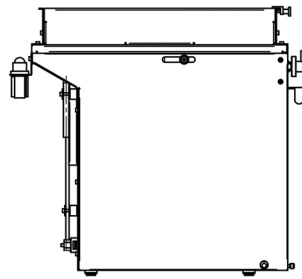
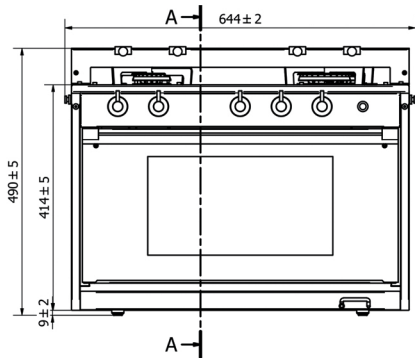

Dimensions (4/5 burners) mm

W 4/5 burners 646 with gimbals

H 495

D 515

Butane / Propane cat I3B/P 30 mbar

LT4GL2 4 burners kW 9,25

LT5GL2 5 burners kW 10,95

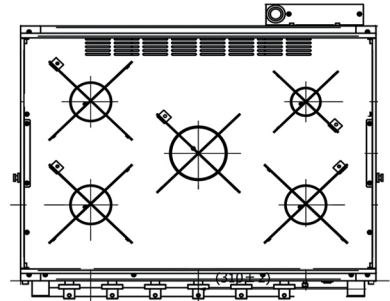
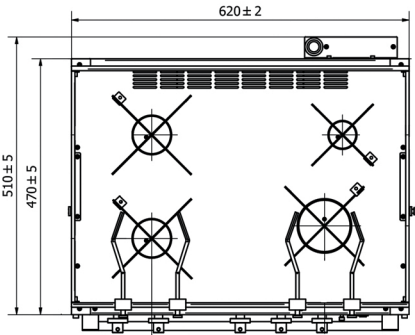

TECHIMPEX
Marine Cookers

TECHIMPEX marinecookers

www.techimpex.it

ELECTRIC COOKERS WITH OVEN

Complete range of electric cookers. The cookers can be equipped with traditional static ovens or with multifunction microwave ovens.

HORIZON3 MICRO INDUCTION (1)

cooker with multifunction microwave oven and 3 induction cooking zones
detachable panholders, exclusive gimball adjusters -
Max power 6,6 kW (4,2kW with PMS) - 53w (w.gimbals) x 59d x 49h cm

HORIZON2 MICRO COMPACT (2)

cooker with multifunction microwave oven and 2 radiant cooking zones
detachable panholders, exclusive gimball adjusters -
Max power 3,8 kW - 48w (w.gimbals) x 44d x 44h cm



HORIZON2 and HORIZON2 COMPACT (3)

cooker with electric oven and 2 radiant cooking zones
detachable panholders, exclusive gimball adjusters -
Max power 4,1 kW - 53w (w.gimbals) x 46d x 48h cm (standard version)
Max power 4,1 kW - 48w (w.gimbals) x 42d x 44h cm (compact version)

HORIZON4 (4)

cooker with electric oven and 4 radiant cooking zones
detachable panholders, exclusive gimball adjusters -
Max power 7,7 kW - 53w (w.gimbals) x 58d x 48h cm

HORIZON4 INDUCTION (5)

cooker with electric oven and 4 induction cooking zones
detachable panholders, exclusive gimball adjusters -
Max power 8,9 kW (4,5 with PMS) - 70w (w.gimbals) x 58d x 52h cm

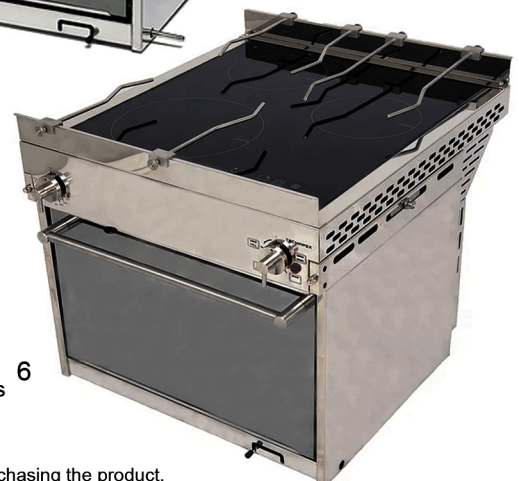

HORIZON3 INDUCTION (6)

cooker with electric oven and 3 induction cooking zones, detachable panholders, exclusive gimball adjusters
Max power 6,7 kW (min 4,3 kW with PMS)- 53w (w.gimbals) x 58d x 52h cm

* All dimensions, datas, images are approximate. Please ask for drawings and technical data sheets before purchasing the product.

Only a few models are represented in this leaflet. **MANY MORE MODELS INCLUDING CUSTOM MODELS ARE AVAILABLE.** Check our website and contact us for more info.

TECHIMPEX marinecookers

www.techimpex.it

GAS COOKERS WITH OVEN

The widest european collection of marine gas cookers. Many optionals available including panholders, gimbals, electronic ignition, 2 or 3 sides heat shields, brass or enamelled burners, grill. stainless steel or enamelled oven chambers and many more

XL2 - XL3 (1)

cooker with 2 or 3 burners, gimbals, panholders
Max power 7,4 kW - 53w (w.gimbals) x 48d x 46h cm



1



2

MARINER2 - MARINER3 (2)

cooker with 2 or 3 burners, gimbals, panholders, stylish mirror glass door, chromed knobs, electronic ignition, exclusive gimbals and panholders adjusters, secured hob grid - Max power 7,4 kW - 53w (w.gimbals) x 49d x 46h cm

TOP2 - TOP3 - TOP4 (3)

premium top of the range cooker with 2,3 or 4 burners, gimbals, sturdy panholders and 8 mm bars secured grid, removable heat shields, stainless steel knobs, electronic ignition, exclusive gimbals adjusters - Max power 7,4 kW - 53w (w.gimbals) x 49d x 46h cm (4 burners)
Max power 9,1 kW - 53w (w.gimbals) x 53d x 51h cm)



4



3



CLASSIC (4)

COMPACT cooker with 2 burners, gimbals, panholders (optional mirror glass left)
Max power 5,5 kW - 48w (w.gimbals) x 44d x 44h cm

MASTERGRILL (5)

COMPACT cooker with external grill, 2 burners, gimbals, panholders
Max power 7,0 kW - 48w (w.gimbals) x 44d x 52h cm

5



TECHIMPEX marinecookers

www.techimpex.it

GAS COOKERS

Compact cookers with 1,2,3,4 burners equipped with flame failure devices on all burners.

ONER (1)

cooker with 1 burner, gimbals, panholders

Max power 1,6 kW - 24w (without gimbals/panholders) x 24d x 8,5h cm

RACER (2)

cooker with 2 burners, gimbals, panholders

Max power 3,2 kW - 51w (w.gimbals installed) x 24d x 27,3 (with gimbals installed) h cm

SKIPPER (3)

cooker with 2 burners, gimbals, panholders

Max power 5,5 kW - 55,7w (w.gimbals) x 28d x 27,3h (with gimbals installed) cm

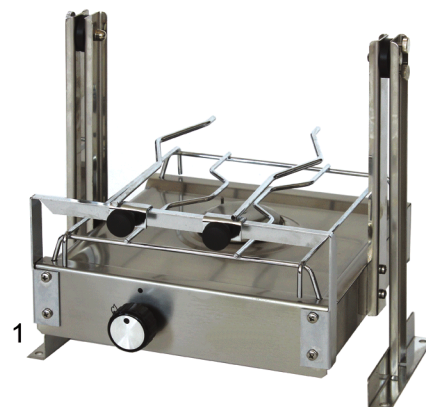

SEAFARER2 (4)

built in hob with 2 burners

Max power 4,7 kW - 47w x 34d x 6.5h cm

SEAFARER1 (5)

Built in hob with 1 burner and integrated panholders

Max power 1,7 kW - 22,5w x 32,5d x 6,5h cm (attention also other dimensions are available for this product)



SEAFARER4 (6)

Built in hob with 4 burners

Max power 6,0 kW - 40w x 50d x 6,5h cm

SEAFARER3 (7)

Built in hob with 3 burners

Max power 5,7 kW - 47w x 39d x 6,5h cm



* All dimensions, datas, images are approximate. Please ask for drawings and technical data sheets before purchasing the product.

Only a few models are represented in this leaflet. **MANY MORE MODELS INCLUDING CUSTOM MODELS ARE AVAILABLE.** Check our website and contact us for more info.

TECHIMPEX marinecookers

www.techimpex.it

ECOBBQ - WOODEN PELLET BARBECUE

Patented system

INNOVATIVE **WOODEN PELLET** BARBECUE - SUPERCOMPACT DESIGN

No electrical power, charcoal or gas is required.

The barbecue is ready to use in just a few minutes. Super easy lighting.

No smoke and the remaining very little dust can be used as organic waste

Burner capacity = 0,8 kg

Duration 1,2 Hours

Extremely powerful (temperature of the plancha plate can reach more than 450°C)

Robust thick stainless steel structure and enamelled plancha

Optional grill rail mount

Optional stainless steel lid with air vent

44 w x 27,5 d 32,5 h cm



GREEN COMBUSTION

THE FIRST MARINE ECO FRIENDLY GRILL

Clean-burning

Pellet burning produces far fewer emissions than any other fuel!

The most innovative cooking system available



NEWS

THE FIRST MARINE PELLET BARBECUE GRILL WITH JUST A FEW CENTS (0,8 KG PELLET = MORE THAN 1 HOUR DURATION!!)
The very small amount of pellets used, means extremely low operating costs (and this also saves space for fuel storage onboard - for ex. a fraction of the space needed for charcoal).

TECHIMPEX marinecookers

www.techimpex.it

BUILT IN ELECTRIC GRILLS

Electric radiant grills with 1,2,3,4 zones

POWERGRILL (1)

with grease tray and 2 cooking zones, locked grid
Max power 2,5 kW 50/60Hz 230/110V
- 51w x 29d x 13,8h cm

SUPERGRILL (2)

Max power 1,3 kW 50/60Hz 230/110V
51/50 w x 29/30d cm (optional premium
FLAT GLASS COOKING surface) - more sizes available

SUPERGRILL WITH GREASE TRAY (3)

Max power 1,5 kW 50/60Hz 230/110V -
50w x 30d cm



flat glass version



COMPACT BBQ (4)

Super compact grill
Max power 1,5 kW - 50/60 Hz 230 or 110V -
34,3w x 39,3d x 8,7h cm



5



4

MEGABBQ 74 (5)

with grease tray and optional lid
Max power 3,0 kW - 50/60 Hz 230 or 110V - 71,5w x 43,3d x 14h cm
MORE SIZES AVAILABLE

MEGABBQ (6)

GIANT size grill with 2 heaters
Max power 2,3 / 6,0 kW - 50/60 Hz 230 or 110V - 50/73 cm diameter (can be purchased
with or without stainless steel mirror polished support)
MORE SIZES AVAILABLE



6

* All dimensions, datas, images are approximate. Please ask for drawings and technical data sheets before purchasing the product.

Only a few models are represented in this leaflet. **MANY MORE MODELS INCLUDING CUSTOM MODELS ARE AVAILABLE.** Check our website and contact us for more info.

TECHIMPEX marinecookers

www.techimpex.it

BUILT IN GAS GRILLS

Gas grills with 1,2,4 zones

MEGABBQ GAS (1)

GIANT SIZE GRILL with 4 burners
grease trays, grids, planchas
Max power 16kW
117w x 70d cm

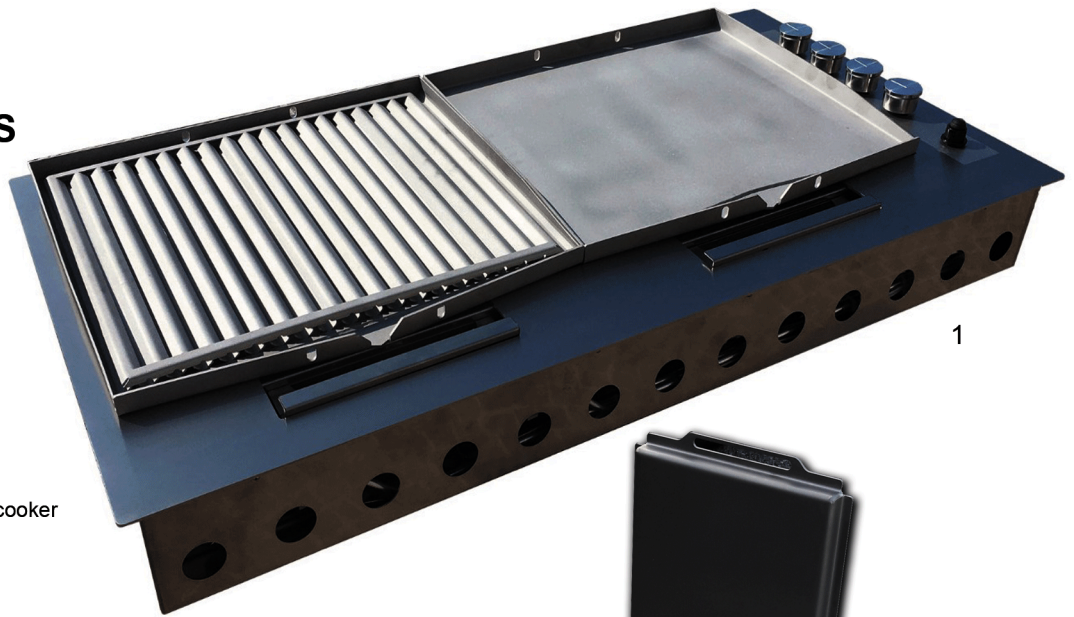

GAS PLANCHA DOUBLE(2)

Max power 6,8 kW
55w x 49d cm - THICK STATINLESS
STEEL COOKING PLANCHA
The grill can be transformed into a gas cooker
(otpionally)



PLANCHA GAS GRIL (3)

THICK STATINLESS
STEEL COOKING PLANCHA
The grill can be transformed into a gas cooker (otpionally)
Max power 3,4 kW - 30w x 52d cm



BUILT IN GAS OVENS

Built in gas ovens

REEF (4)

super compact built in oven
Max power 1,1 kW - 48,5w x 46d x 24h cm

ELECTRIC VERSION AVAILABLE 1,7kW 50760 Hz - 110/230V



MAXI OVEN (5)

GIANT size grill with 2 heaters, TIMER, THERMOSTAT
Max power 1,7 kW - 55w x 43,4d x 54h cm

ELECTRIC VERSION AVAILABLE 1,7kW 50760 Hz - 110/230V

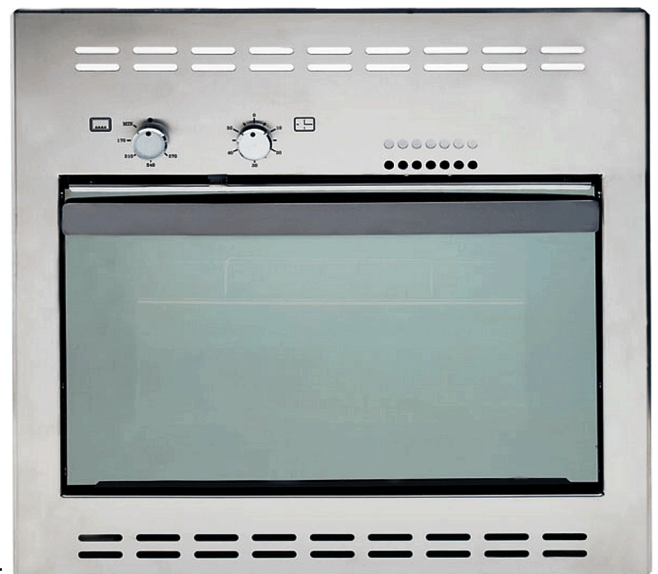

TECHIMPEX marinecookers

www.techimpex.it

CUSTOM MADE GRILLS, BARBECUES

Gas, electric, charcoal

MEGABBQ GAS (1)

GIANT SIZE GRILL with 4 burners
CUSTOM SPECIAL VALTELLINA STONES

Max power 16kW

117w x 70d cm

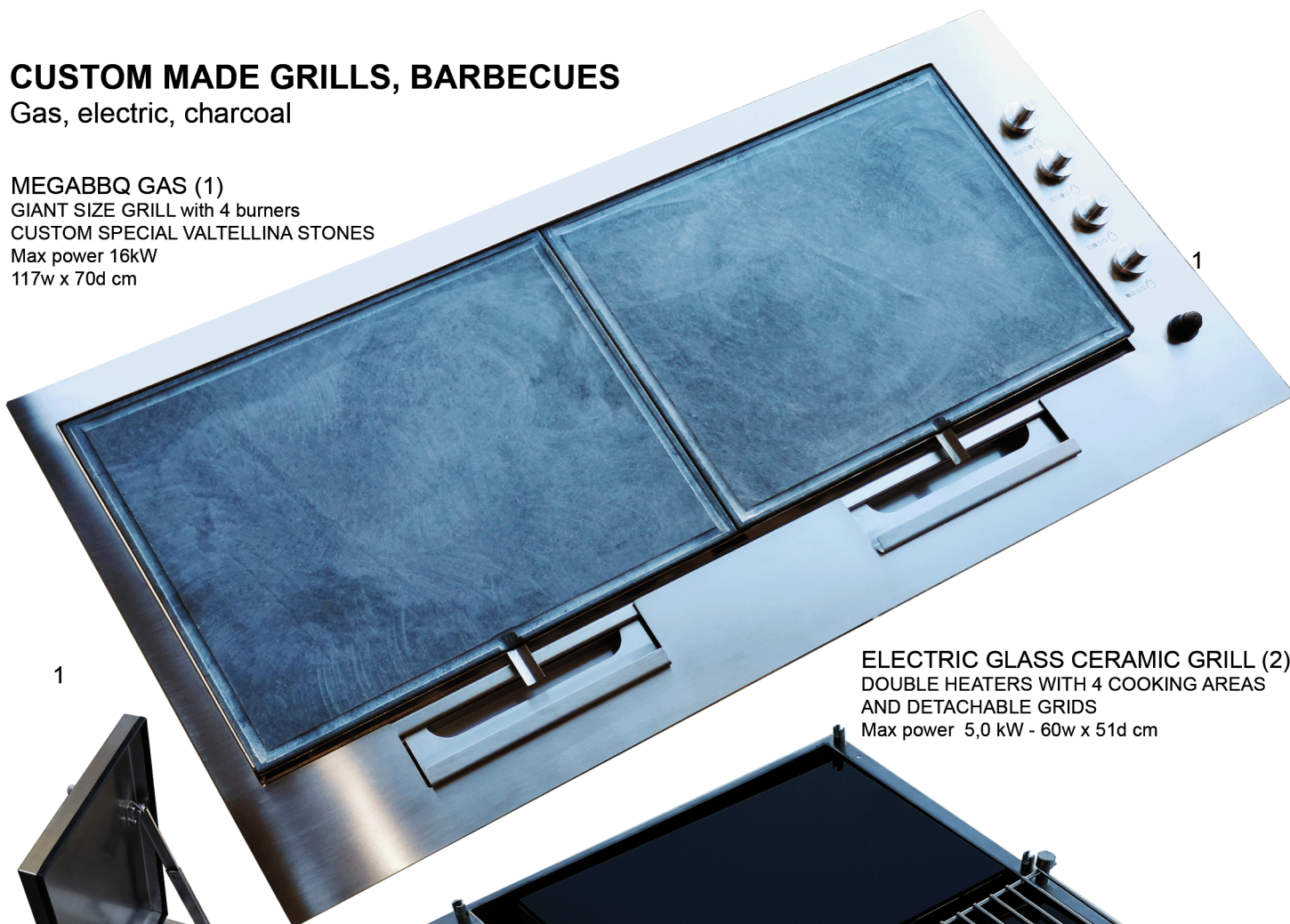

ELECTRIC GLASS CERAMIC GRILL (2)

DOUBLE HEATERS WITH 4 COOKING AREAS
AND DETACHABLE GRIDS

Max power 5,0 kW - 60w x 51d cm

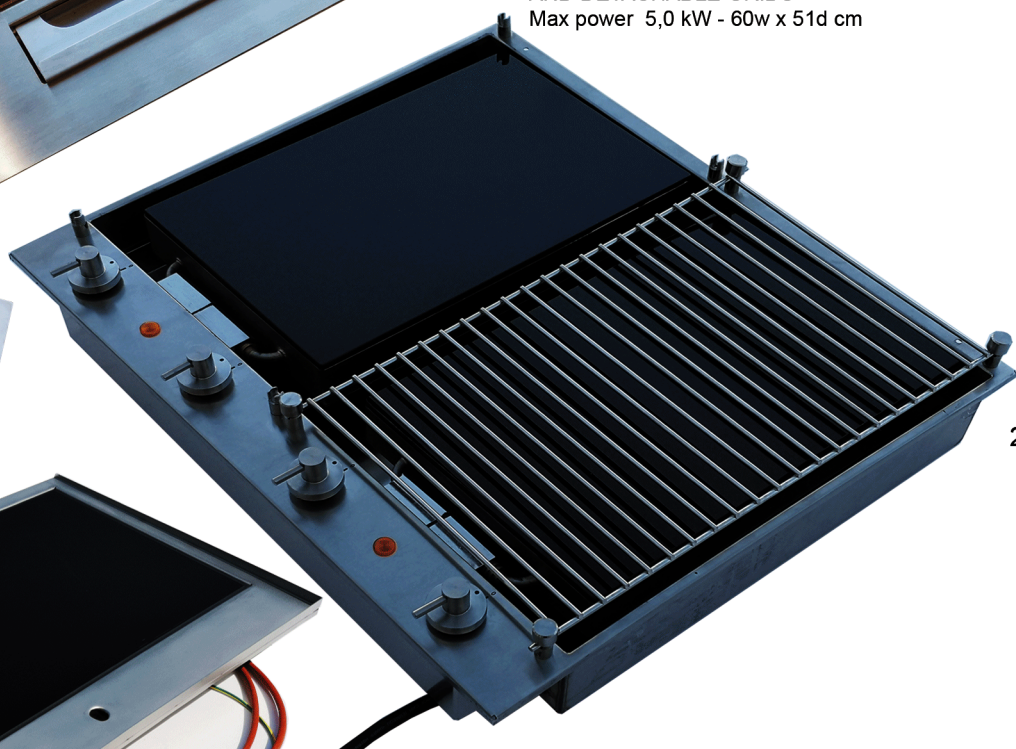

ELECTRIC GLASS CERAMIC GRILL (3)

DOUBLE HEATERS GIANT SIZE GRILL with
grease channel and unique design

Max power 3,0 kW - 70w x 40d cm - 230V 50/60 Hz

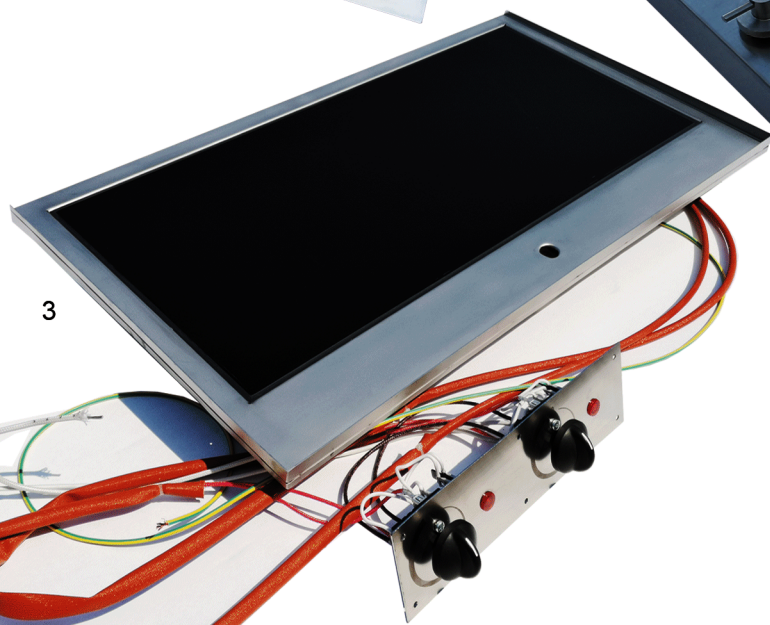

WATER TIGHT 316 ST. STEEL CASE (4)

Custom made case with seal and locked lid for
electric bbqs

1

4

3

2

* All dimensions, datas, images are approximate. Please ask for drawings and technical data sheets before purchasing the product.

Only a few models are represented in this leaflet. **MANY MORE MODELS INCLUDING CUSTOM MODELS ARE AVAILABLE.** Check our website and contact us for more info.

TECHIMPEX marinecookers

www.techimpex.it

CUSTOM MADE GIMBALLED COOKERS

Gas or electric cookers - we can build cookers casings with our patented or exclusive gimbal and panholders systems using our own brand cookers or any other brand specified by the customer.

ELECTRIC GIMBALLED
COOKERS (1)
6 INDUCTION COOKING
AREAS AND LARGE
MULTIFUNCTION
ELECTRIC OVEN
100w x 60d X 60Hcm



CUSTOM MADE TOPS

COMPLETE TOP WITH SINK,
WATER TAP, DOUBLE LID AND
CUSTOM MADE GRILL (1)
100w x 60d X 60Hcm



* All dimensions, datas, images are approximate. Please ask for drawings and technical data sheets before purchasing the product. Only a few models are represented in this leaflet. **MANY MORE MODELS INCLUDING CUSTOM MODELS ARE AVAILABLE.** Check our website and contact us for more info.

TECHIMPEX marinecookers

www.techimpex.it

BUILT IN GLASS CERAMIC ELECTRIC HOBS

Electric radiant or induction hobs with 1,2,3,4 (5,6 and more) zones

INDUCTION HOBS are equipped with an electronic system (ES) which permits to limit the power of the whole hob to a mere 2,8 kW !

CRYSTAL4 INDUCTION (1)

hob with 4 cooking zones
Max power 7,2 kW (2,8 kW ES) 58w x 51d cm

CRYSTAL3 INDUCTION (2)

hob with 4 cooking zones
Max power 5,2 kW (2,8 kW ES) - 44w x 51d cm

CRYSTAL2 INDUCTION (3)

hob with 4 cooking zones
Max power 3,6 kW (2,8 kW ES) - 29w x 51d cm

PANHOLDERS (4)

All hobs can be supplied with different models of patented panholders to be fixed on the furniture near the hobs or directly attached to the hobs stainless steel frames (see radiant hobs below).

CRYSTAL1 RADIANT (5)

hob with 1 cooking zone
Max power 1,2 kW - 50/60 Hz 230 or 110V - 30w x 30d cm

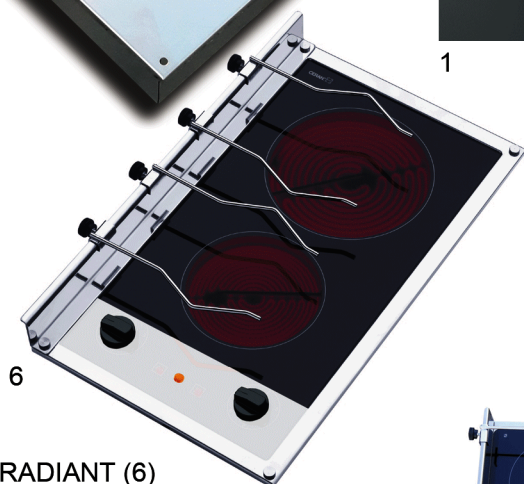
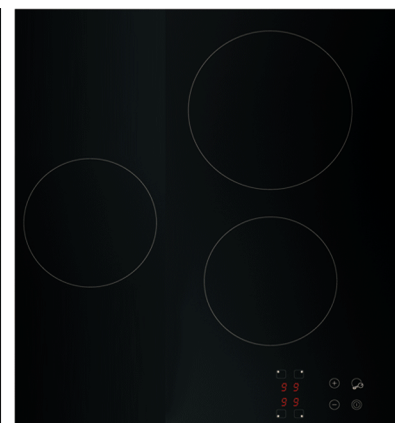
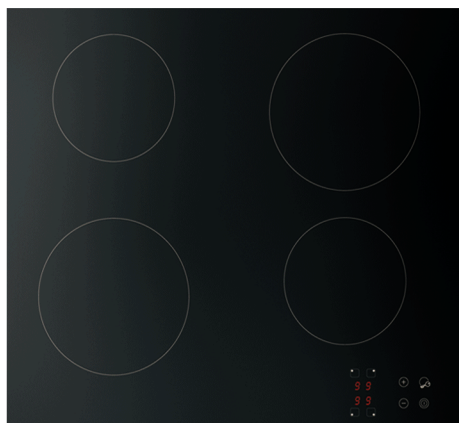
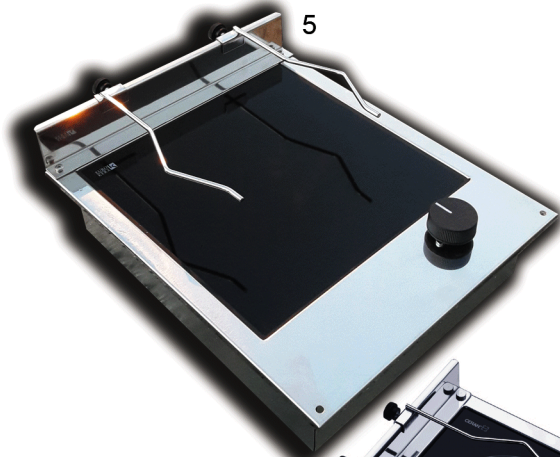
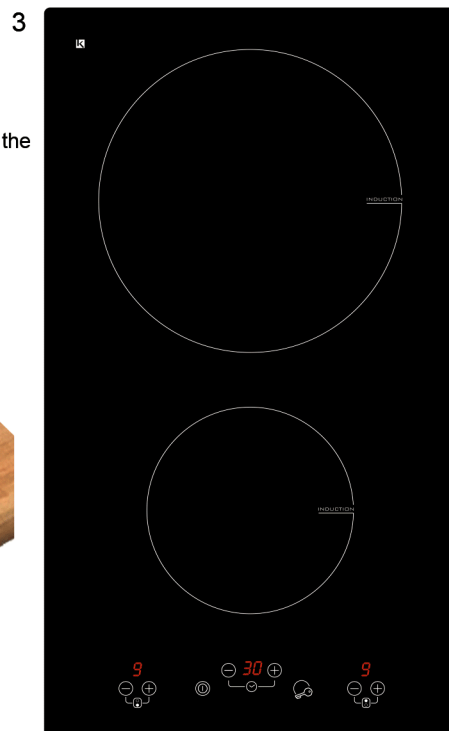

CRYSTAL2 RADIANT (6)

hob with 4 cooking zones, panholders
Max power 3,0 kW - 50/60 Hz 230 or 110V - 30w x 51.9d x 46h cm

CRYSTAL4 RADIANT (7)

hob with 4 cooking zones, panholders
Max power 6,0 kW - 50/60 Hz 230 or 110V - 51,7w x 58,7d cm

CRYSTAL3 RADIANT (8)

hob with 3 cooking zones, panholders
Max power 4,7 kW - 50/60 Hz 230 or 110V - 46,2w x 50.8d cm

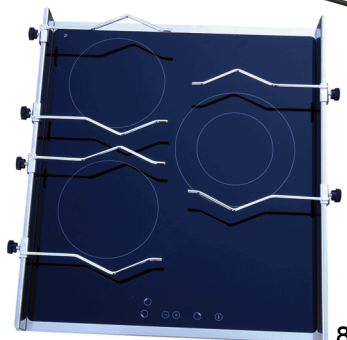

* All dimensions, datas, images are approximate. Please ask for drawings and technical data sheets before purchasing the product.

Only a few models are represented in this leaflet. **MANY MORE MODELS INCLUDING CUSTOM MODELS ARE AVAILABLE.** Check our website and contact us for more info.

TECHIMPEX marinecookers

www.techimpex.it

BUILT IN GLASS CERAMIC ELECTRIC HOBS

Induction hobs with 2,4 (and more) zones with POWER SYSTEM CONTROL (PS)

INDUCTION HOBS are equipped with an electronic system (PS) which permit to control the power of the cooking areas in such way that the power absorbed in amps is effectively controlled directly from the user. For example if the cooking zone is set at the min the absorption is just a few hundred watts.

CRYSTAL2 INDUCTION PS (1)

hob with 4 cooking zones - BRIDGE FUNCTION (2 zones can be connected)
Max power 3,7 kW - 58w x 51d cm

CRYSTAL4 INDUCTION PS (2)

hob with 4 cooking zones - BRIDGE FUNCTION (2 zones can be connected)
Max power 6,7 kW - 58w x 51d cm

PANHOLDERS (3)

All hobs can be supplied with different models of patented panholders to be fixed on the furniture near the hobs or on request directly attached to the hobs stainless steel optional frames



INDUCTION HOBS WITH INTEGRATED HOOD

These hobs are equipped with a special electronic system (PS) to limit the power use (see above) and also with a patented hood. No more need to install separated hoods. Simplified installation.

CRYSTAL4 INDUCTION PS CENTRAL HOOD(4)

hob with 4 cooking zones
Max power 7,4 kW - 58w x 51d cm

CRYSTAL4 INDUCTION PS SIDES HOOD(5)

hob with 4 cooking zones - BRIDGE FUNCTION (2 zones can be connected)
Max power 6,8 kW - 83w x 51d cm

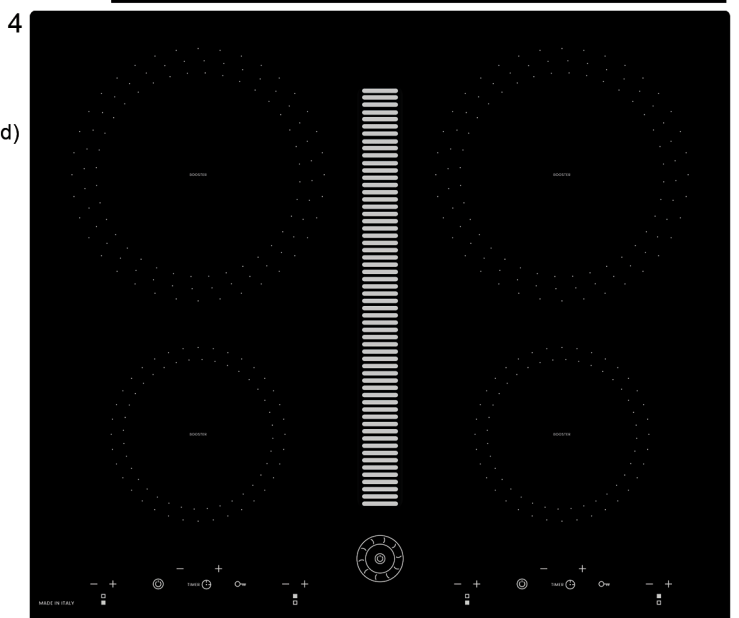
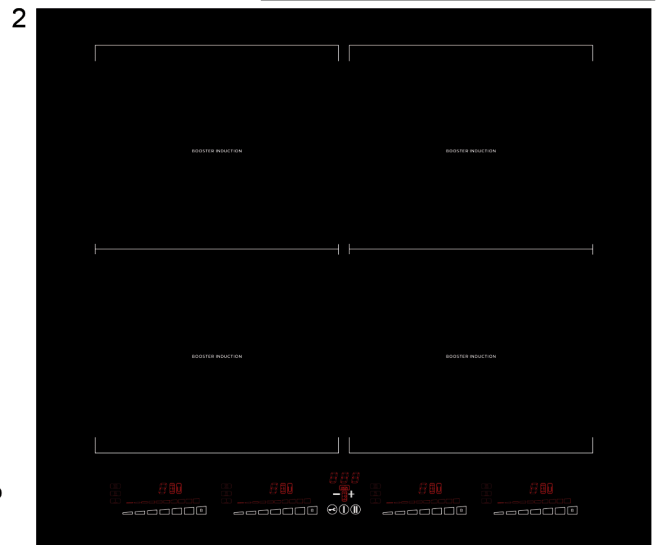
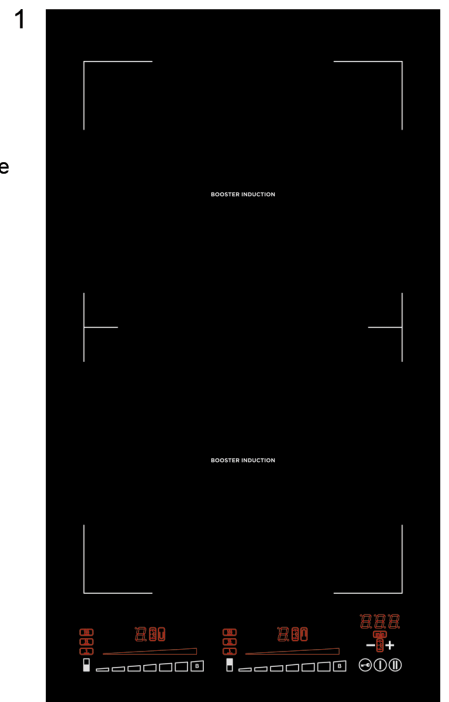
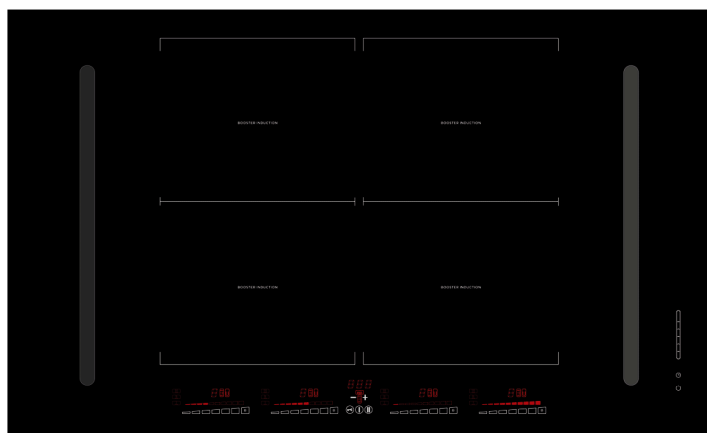

* All dimensions, datas, images are approximate. Please ask for drawings and technical data sheets before purchasing the product.

Only a few models are represented in this leaflet. **MANY MORE MODELS INCLUDING CUSTOM MODELS ARE AVAILABLE.** Check our website and contact us for more info.

Virtus | Raffaello

We've brought to life an extraordinary product, a true culinary innovation.

Our inspiration? A passion for cooking, because we are Italians, and a love for high-quality food.

We've pushed the boundaries, creating something truly revolutionary, an authentic game changer. When the surface is sealed flawlessly onto the countertop, the cooktop becomes perfectly watertight. On a boat, this feature becomes absolutely essential.

But that's not all. The ability to adjust the temperature to over 500°C not only allows you to grill directly on the glass but also to cook with pots, opening up new culinary horizons. The efficiency is extraordinary; when it comes to grilling, it can even surpass induction systems.

The design is elegant and minimalist, seamlessly blending with the aesthetics of modern boats.

Cleaning is a breeze, thanks to the glass that's practically impervious to bacterial retention. This means our product is much more hygienic than other barbecues, often a nightmare to clean, if not impossible to sanitize.

Moreover, flavors never mix, as the glass retains nothing. Our system is incredibly fast and powerful, guaranteeing unmatched cooking results. And there's another ace up our sleeve: unlike traditional systems, our insulated resistors are practically immune to the wind, solving a common problem with many traditional barbecues.

It's time to change the game in the galley and embrace innovation with our unique product. The culinary experience will never be the same again!

Abbiamo dato vita a un prodotto straordinario, una vera innovazione culinaria. La nostra ispirazione? La passione per la cucina, perché siamo italiani, e l'amore per il cibo di qualità.

Ci siamo spinti oltre, creando qualcosa di veramente rivoluzionario, un autentico game changer. Quando il nostro piano viene sigillato in modo impeccabile sulla superficie, il piano cottura diventa ermeticamente perfetto. Su una imbarcazione, questa caratteristica diventa cruciale.

Ma non è tutto qui. La capacità di regolare la temperatura fino a oltre 500°C non solo consente di grigliare direttamente sul vetro, ma anche di cucinare con le pentole, aprendo nuovi orizzonti culinari. L'efficienza è straordinaria; quando si tratta di grigliare, può persino superare i sistemi a induzione. Il design è elegante e minimalista, si fonde armoniosamente con l'estetica delle moderne imbarcazioni.

La pulizia è un gioco da ragazzi, grazie al vetro praticamente immune alla ritenzione batterica. Questo significa che il nostro prodotto è molto più igienico rispetto ad altri barbecue, spesso un incubo da pulire, se non impossibili da igienizzare. Inoltre, i sapori non si mescolano mai, poiché il vetro non trattiene nulla. Il nostro sistema è incredibilmente veloce e potente, garantendo risultati di cottura ineguagliabili. E c'è un altro asso nella manica: a differenza dei sistemi tradizionali, le nostre resistenze isolate sono praticamente protette dal vento, risolvendo un problema comune a molti barbecue tradizionali di bordo.

È arrivato il momento di cambiare le regole del gioco in cucina e abbracciare l'innovazione con il nostro prodotto unico. L'esperienza culinaria non sarà mai più la stessa!



Virtus | Raffaello

Two models available:

VIRTUS 2500W
RAFFAELLO 1800W
230V 50/60 Hz



Virtus _____

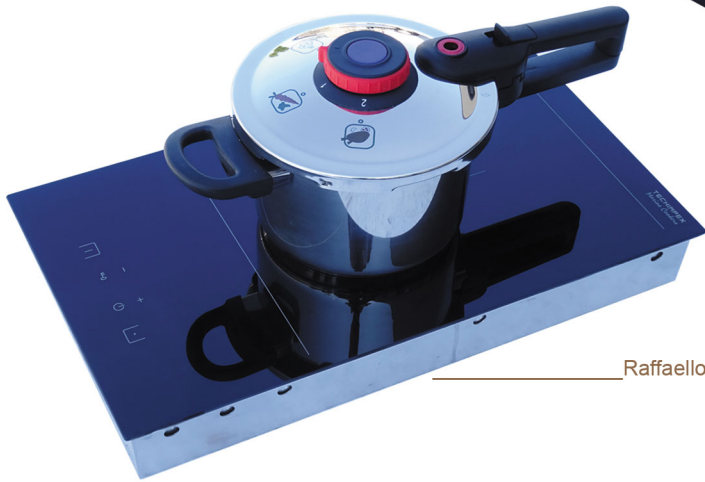

Raffaello _____



Raffaello _____

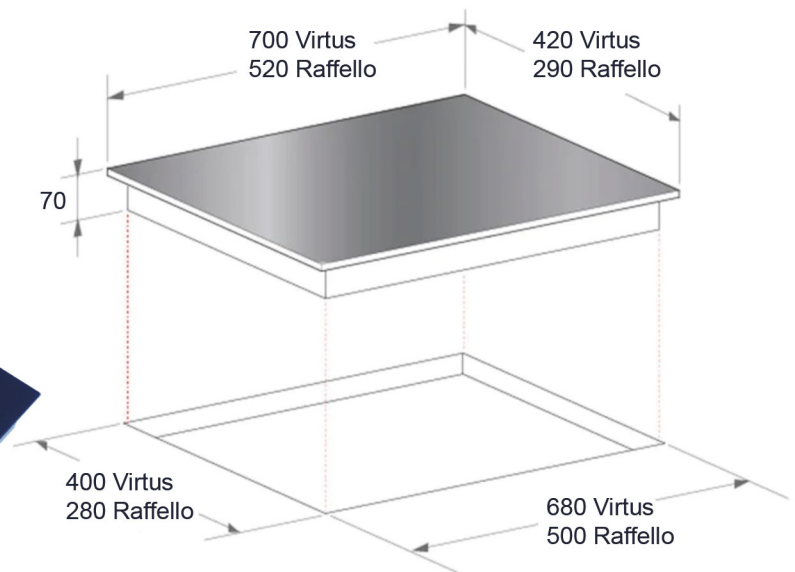

* all dimensions are approximate

TECHIMPEX
Marine Cookers

Via Cosmo, 14 - 31015 Conegliano (TV) - Italia - T. +39 0438 1840230 www.techimpex.tv info@marinecookers.com

VICTOR | FORTIS

Victor (Teppan Yaki) e Fortis (Griddle) sono i primi grill di altissima pensata specificatamente per la nautica.

I primi ad essere realizzati con chassis in acciaio inox marino e sealed handles.

Perfino la griglia di cottura (nel caso di Fortis) viene realizzata con uno speciale materiale resistente alle intemperie e con un trattamento superficiale esclusivo antiaderente di altissimo livello qualitativo.

Le cornici sono realizzate in acciaio inox marino di forte spessore (ben 3 mm!).

Completano questa gamma gli speciali paraventiparafiamma perimetrali opzionali.

Victor (Teppan Yaki) and Fortis (Griddle) are the first high-end grills specifically designed for marine use.

They are the first to be constructed with a marine-grade stainless steel chassis and sealed handles.

Even the cooking grates (in the case of Fortis) are made from a special weather-resistant material and feature a top-quality, exclusive non-stick surface treatment.

The frames are crafted from heavy-duty marine-grade stainless steel (a robust 3 mm thickness!).

Completing this range are the optional special perimeter windshields and flame guards.

Dati Tecnici - Technical Datas

230Vac 50/60 Hz

380 x 520 mm

2400 W~

TECHIMPEX
Marine Cookers

Via Cosmo 14 - 31015 Conegliano (TV) Italia
T. +39 0438 1840230 www.techimpex.tv



ECLISSE

Top cucina in SYNTEX con piano cottura integrato, completamente invisibile.

Ben 8 colorazioni possibili.

- Resistente agli shock termici
- Resistente alle macchie, graffi ed urti
- Raffreddamento rapido
- Continuità Estetica
- Design di altissima gamma

I top cucina possono essere completamente personalizzati su disegno del cliente. I lavelli possono essere realizzati con lo stesso materiale del top oppure in acciaio inox. I piani cottura sottostanti al top sono ad induzione con 2 o 3 zone di cottura ad alte prestazioni.

Top kitchen in SYNTEX with a seamlessly integrated, entirely invisible cooktop. Available in 8 captivating color options.

- Resistant to thermal shocks
- Stain, scratch, and impact-resistant
- Rapid cooling
- Uninterrupted aesthetic continuity
- High-end design

Our kitchen tops can be fully customized according to the customer's specifications. Sinks can be crafted from the same material as the top or in stainless steel. The cooktops beneath the surface are induction-based, featuring 2 or 3 high-performance cooking zones

TECHIMPEX
Marine Cookers

Via Cosmo 14 - 31015 Conegliano (TV) Italia
T. +39 0438 1840230 www.techimpex.tv

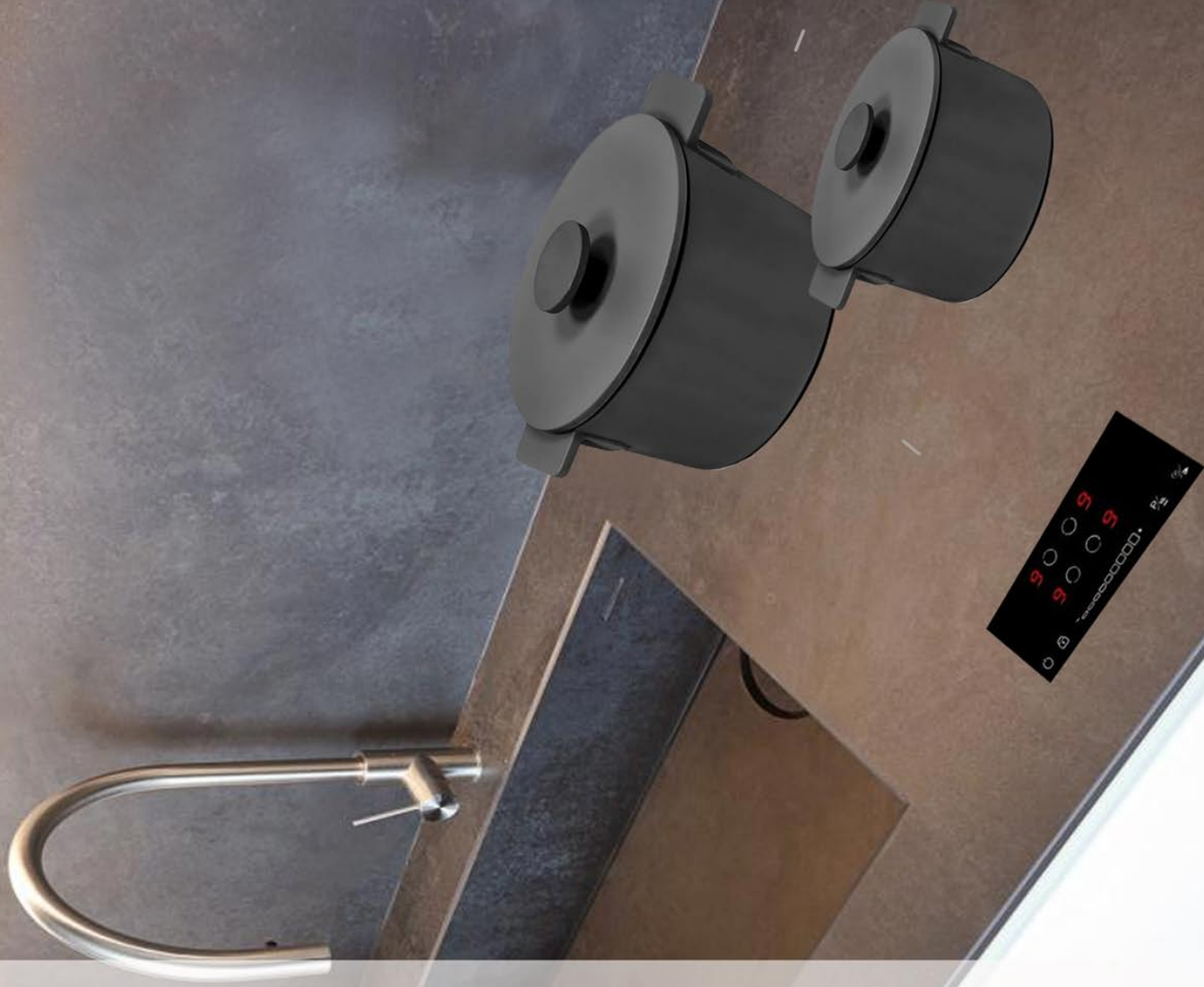

TECHIMPEX

Marine Cookers

Our company houses a boutique laboratory, specializing in crafting innovative and exclusive gimbaling modules with a modern and minimalist design, tailored perfectly for today's cutting-edge vessels.

The structures of our gimbaling modules are exceptionally robust, constructed with thick stainless steel, and feature durable, practical, and aesthetically pleasing latching and tilting systems

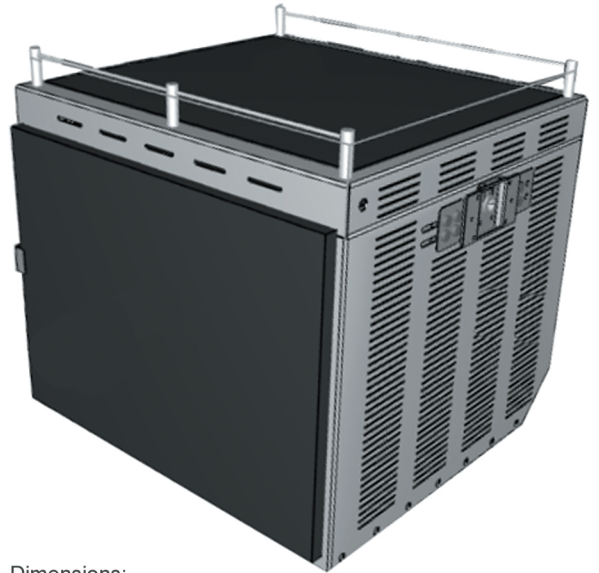

Dimensions:
W 651 x H 590 x D 599 mm ~
(It is possible to customize the module's dimensions)





TECHIMPEX
Marine Cookers

Via Cosmo 14
31015 Conegliano (TV) ITALIA
www.techimpex.tv
info@marinecookers.com
T. +39 0438 1840230

LAGUNA

Introducing our exquisite collection of high-quality crystal cooktops, featuring an exclusive shatterproof glass safety system that takes the worry out of cooking.

Not only do these cooktops boast stunning design, but their mechanically secured grates are also fully removable and washable, ensuring effortless cleaning for your convenience. Elevate your cooking experience with style, safety, and simplicity.

A complete range of impeccably designed and incredibly sturdy pot support systems is optionally available for each individual model.

Laguna 3
5,1 kW - Butane Propane - 30 mbar (I3 B/P)

Dimensions 420 x 360 mm

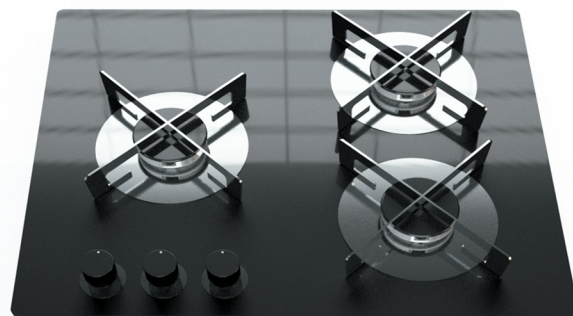

Laguna 2
3,4 kW - Butane Propane - 30 mbar (I3 B/P)

Dimensions 380 x 270 mm

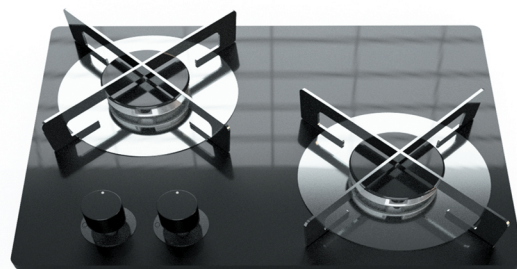

Riva 1
3,4 kW - Butane Propane - 30 mbar (I3 B/P)

Dimensions 285 x 500 mm



Laguna 1
1,7 kW - Butane Propane - 30 mbar (I3 B/P)

Dimensions 225 x 270 mm

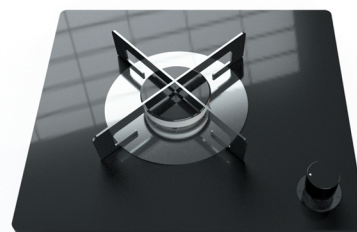

MINIMO

This is the induction cooktop the market has been waiting for.

Compact yet incredibly high-performing.
With a separate control, allowing you to make the most of the entire cooking surface.

A robust pot support system is optionally available

Minimo
2,0 kW - 230Vac - 50 Hz
Dimensions 300 x 300 mm

