

MODEL HORIZON3 IND.VENTILATED CES3INDUZVL00 GIMBALLED ELECTRIC COOKER WITH OVEN

INTRODUCTION

Thank you for selecting this Electric Galley Range/Appliance.

Your unit was carefully inspected and tested at our factory. Please take the time to read this manual carefully.

Many of its instructions are essential to the safe operation of your new Electric Range.

Because of the continuing refinement of our product designs, your appliance may possess features not discussed in the manual.

We have tried to supply all the information you might need, so please take time to read this manual before installing and using your appliance.

The manufacturer advises strongly against unauthorized modification of this product. Do not attempt to modify the technical characteristics of the appliance as this may become dangerous to use.

Warning: it is recommended that this appliance is professionally serviced every year to verify if the appliance is in perfect condition and for servicing if necessary.

The manufacturer does not take any responsibility for damages due to wrong installation or caused by wrong use of the appliance.

This appliance must exclusively be used to cook food. Do not use the appliance for purposes which are different from those for which it has been made.

After having unpacked the appliance, check to ensure that it is not damaged. If you have any doubts, do not use and consult your supplier or a professionally qualified technician.

Packing elements and the appliance itself (i.e. plastic bags, polystyrene foam, nails, packing straps, etc.) should not be left around within easy reach of children as these may cause serious injuries. The packaging material which is recyclable is marked with the recycling symbol.

If you should decide not to use this appliance any longer (or decide to substitute an older model) before disposing of it, it is recommended that it be made inoperative in an appropriate manner in accordance to health and environmental protection regulations ensuring in particular that all potentially hazardous parts be made harmless, especially in relation to children who could play with old appliances.

IMPORTANT PRECAUTIONS AND RECOMMENDATIONS FOR USE OF ELECTRICAL APPLIANCES

Use of any electrical appliance implies the necessity to follow a series of fundamental rules, in particular:

- NEVER TOUCH THE APPLIANCE WITH WET HANDS OR FEET OR ANY OTHER PART OF THE HUMAN BODY
- DO NOT OPERATE THE APPLIANCE BAREFOOTED
- DO NOT ALLOW CHILDREN OR DISABLED PEOPLE TO USE THE APPLIANCE WITHOUT YOUR SUPERVISION

The manufacturer cannot be held responsible for any damages caused by improper, incorrect or unreasonable use of the appliance.

**KEEP CHILDREN AWAY FROM THE COOKING HOB WHEN IT IS IN USE
BEFORE ANY CLEANING OR MAINTENANCE SWITCH OFF THE ELECTRICITY TO THE COOKTOP.**

**RISK OF FIRE. DO NOT LEAVE INFLAMMABLE MATERIAL ON THE COOKTOP.
MAKE SURE THAT THE ELECTRICAL CABLES OF OTHER APPLIANCES INSTALLED NEARBY CANNOT COME INTO CONTACT WITH THE APPLIANCE.**

Provide ventilation when the stove is in use. Do not use for space heating. Do not cover.

Do not use unattended.

This appliance must be installed according to the current standards in practice in the country of destination and only by a competent person, that's to say a professional who is authorized by the manufacturer and who knows all the current standards in practice in the country of destination

The cleaning operations of the appliance must be done by a competent person.

It is recommended that a competent person explains the content of this booklet to ensure the operator is conversant with its operation

Do not use your Range as a source of heat

DO NOT TOUCH SURFACE UNITS OR AREAS NEAR UNITS

Heating elements may be hot even though they are dark in color. Areas near surface units may become hot enough to cause burns. During and after use, do not touch, or let clothing or other flammable materials contact surface units or areas near units until they have had sufficient time to cool.

Before using your cook-top, check each time that the bottom of the saucepan and the cooking zone are clean and dry.

Lift up the sauce pans; sliding them across the cook-top can lead to superficial scratches.

Avoid peeling vegetables over the cook-top as this could lead to grit on the surface and subsequent scratching.

Use saucepans which are large enough to avoid spillage onto the cooktop, especially if a saucepan contains any sugar as this can cause irreparable damage to the glass ceramic.

Keep the surface of the cook-top clear; above all do not keep plastic or Aluminum packing on it which could melt and damage the cook-top.

ELECTRICAL REQUIREMENTS

VOLTAGE 230V FREQ. 50-60 Hz

HOB - COOKTOP

Surface Elements	2 x 1600 W
	1 x 2000 W

OVEN

Oven Bottom Element	750 W
Oven Top Element	750 W
Grill Broiler	1500 W
Circular Rear Element	1650 W
Fans	30 W
Oven Lamp	40 W

Maximum 7670 W – 34 A 230VAC

**** POWER MANAGEMENT SYSTEM:**

The appliance is equipped with an electronic device (which can be adjusted by the installer) which can be used to set the cooktop power limit.

Instructions for power management system and diagram supplied apart.

INSTALLATION

The appliance must be installed by a specialized installer.

Unpacking =

Remove all plastic coating before use. Pay attention not to hurt yourself with any part of the appliance when unpacking and installing it or during maintenance operations which should be done only by authorized specialized technicians.

To eliminate the risk of burns or fire by reaching over the heated surface, cabinet storage space located above the surface units should be avoided. If cabinet storage is to be provided, the risk can be reduced by installing a range hood that projects horizontally a minimum of 15 cm beyond the bottom of the cabinets

Minimum Clearances to Adjacent Walls and Overhead Cabinets (see drawing and image supplied separately):

D	Bolt hole for gimbals stopper 10 mm diameter
L1	525 mm
O	Vertical distance between the gimbals axis and the lower part of the cabinet where the appliance is installed
M	Distance gimbals- axis - front part of the cabinet where the appliance is installed approx (adjustable)
N	Distance gimbals-axis – rear part of the cabinet where the appliance is installed approx (adjustable)
P	Hole for ventilation (air flow)
Q	Holes for ventilation (air flow)
S	Air flow
R	Vertical distance between the gimbals-axis and the axis of the hole of the gimbaling stopper (bolt)
R1	Horizontal distance between the gimbals axis and the axis of the hole " D " for the gimbals stopper (bolt) - adjustable
D1	Min 750 mm - min distance between the hob burner and the wall above the hob

*All dimensions are approximate

ELECTRICAL CONNECTION

This product must be installed in accordance with national and local electric codes. It must be supplied with the rated voltage and frequency and hardwired to its own branch circuit, protected by an appropriate sized circuit breaker.

THE CABLE MUST BE HEAT AND FIRE RESISTANT – IT MUST WITHSTAND A TEMPERATURE OF AT LEAST 90°C (type H05V2V2-F).

The cable must be well connected.

Before making the electrical connections, check that:

- the ground wire is 2 cm longer than the other cables;
- the system ratings meet the ratings indicated on the identification plate fixed on the lower part of the work top;
- the system is fitted with efficient ground wires in accordance with the laws and current standards.

GROUNDING IS MANDATORY BY LAW

If the appliance is not supplied with a cable and /or suitable plug, use material suitable for the absorption value indicated on the identification plate on the appliance and the operating temperature.

WARNING THE ELECTRICAL CABLE must be installed in such a way that it cannot touch the appliance bottom part or with other electrical appliances nearby (for example built in oven).

Also cables of other appliances nearby must be kept far from this appliance whose parts become HOT.

If wishing to make a direct connection to the mains, an omnipolar switch must be installed with a minimum 3 mm opening between the contacts and appropriate for the load indicated on the plate and in accordance with the current standards (THE YELLOW/GREEN ground conductor must not be disconnected by a switch).

When the appliance has been installed the omnipolar switch must be easily reachable.

POSITIONING

The appliance was built in order to be installed the way it is illustrated in the drawing / diagrams supplied.

WARNING: FIRE DANGER!

If any other appliance that produce heat need to be installed near this appliance, IT IS NECESSARY THAT appliances are adequately thermally isolated.

Failure to follow this precaution, could cause a malfunction of the APPLIANCE.

- The appliance becomes hot
- check that the material of the furniture where the appliance is installed is heat and fire resistant and flame retardant
- check that on the furniture where the appliance is installed there are ventilation openings as per attached drawing
- plastic parts of the furniture, glues, etc...where the appliance is installed must be heat resistant and flame retardant (more than 90°C) otherwise after some time they will deform or be destroyed
- the minimum distance between the hob and a hood must be that indicated in the instructions of the hood itself (at least 750 mm as per attached drawing)

Only a competent technician must install the appliance, the installation can be made on non inflammable and flame retardant furniture made of metal, wood, stone, etc provided they have a heat resistance above 90°C, that's to say they must withstand a temperature of more than 90°C

Follow the attached drawing to install the appliance.

The distance between the appliance and the surrounding and nearby furniture must be such that there is enough ventilation.

OPERATION

OVEN

Your appliance is equipped with 2 control oven front knobs:

- 1 Oven control knob = selection of the oven heating elements (10 different positions possible + OFF position)
- 1 Thermostat control knob = temperature inside the oven
- Hob = see instructions supplied separately

WARNING: CHILDREN ARE NORMALLY NOT ABLE TO SEE THE HOT SYMBOL SO CHILDREN AND FOR EX DISABLED MUST BE KEPT AWAY FROM THE APPLIANCE.

Please ensure when the appliance is turned on, that there are no empty pots left on the hob. When you have finished cooking, switch off the heating element with the control indicated in the present booklet.

Oven/Broiler-Grill Operation

The oven and broiler are controlled by the same control knob.

10+OFF Positions can be chosen (identified by symbols near the control knob)

Turning the knob clockwise will select the following functions:

- 0) upright position above the knob 0 - OFF
- 1) lower heating element + ventilation
- 2) lower heating element + upper heating element
- 3) lower heating element
- 4) rear circular heating element + ventilation, lamp off - ECO mode
- 5) upper grill element
- 6) upper grill element + ventilation
- 7) lower heating element + upper heating element + ventilation
- 8) rear circular heating element + ventilation
- 9) rear circular heating element + upper heating element + ventilation
- 10) lamp

To operate the oven elements turn the control knob to the desired setting (see above).

Turn the thermostat control knob clockwise and set the desired temperature.

Attention: the red light is on when the device is powered i.e. energized. When the device is not in operation, the indicator light must be off! To turn off the indicator light, the switch upstream of the appliance must be turned off (the appliance must have a dedicated line and there must be an appropriate switch upstream of the appliance!).

The door must be kept closed while you are using the oven to cook.

When cooking is complete, turn the control off. Until unit has cooled completely, use caution when working around it.

Clean the oven interiors completely (oven sides, oven grid, oven trays, oven door).

Allow the oven to heat for 2 hours before using it for the first time, in order to expel any smells before the introduction of food. The oven must be pre-heated for approximately 10 minutes before introducing the food.

During cooking, adjust the temperature with the oven control knob, according to what is needed. We can expect a maximum temperature above 220°C.

To turn off the appliance, turn both knobs (the thermostat control knob and the oven control knob) on the front to the OFF position. After that, turn off the switch upstream of the appliance that interrupts the appliance's power line. The red light on the appliance must go out!

Oven trivet and baking tray

The oven shelf and baking tray must be fitted correctly through the guides.

Oven's door - door safety lock

The oven's door is supplied with an automatic locking device on the upper part, that's to say a lever which must be used to lock the door.

In order to open the door it is necessary to press the door safety lock.

After having closed the door the door safety lock will automatically lock the door to the oven, for safety reasons it can be easily checked if the door safety lock is working properly: after having closed the door, pull the door. If the door safety lock works properly you cannot open the door unless you previously press the door safety lock.

Important caution: do not place the baking sheet directly under the grill as this will cause the appliance to overheat. Only the grill should be used under the oven grate!

Also, do not use the grill for more than 15 minutes!

HOB / COOKTOP

See instructions for induction hob supplied separately.

Cooker gimbaling safety system

When the cooker is not in use the bolt placed on the right front of the appliance must be closed (the system is placed on the lower front part of the appliance on the right).

Gimbals regulators - available for certain models only (optional)

The appliance could be equipped with a patented system which permits to regulate the position of the appliance in respect of the gimbals to have the appliance always well balanced. To regulate the position of the appliance, you just have to turn at the same time the 2 knobs placed on the highest part of the cooker sides (there is one knob on the left front side and one knob on the right front side), you can turn the knobs clockwise or anti-clockwise. By doing this operation you will regulate the position of the appliance in respect of the gimbals axis. You can turn the knobs till you see that the cooker is perfectly balanced. This device is particularly helpful when more pans must be placed at the same time inside on the hob.

Do not regulate while the appliance is in use.

Warning: rear fan must always be on when the appliance is functioning. The fan can be in any case turned off with the blue switch on the back side of the cooker.

CLEANING & MAINTENANCE

Ceramic Glass Cooktop Cleaning Instructions

All stain or deposit on the cook-top surface must be cleaned off quickly once the cook-top has cooled down, before re-using the cook-top

Exception: In the case of sugar deposits, remove all residues before the cook-top cools down (Be careful not to burn yourself!)

Important: Only use cleaning products that have been specifically designed for glass ceramic cook-tops.

If the deposit is minimal, simply wipe off with a dry cloth.

If the deposit is more prominent, clean off with a moist, soapy sponge and rinse off.

If the deposit does not clean off easily, use a non-abrasive scratch pad and a specially adapted glass-ceramic cleaning product. If the deposit does not clean off with any of the above mentioned methods, use a razor blade scraper, specially designed for glass ceramic cook-tops.

Having successfully cleaned the cook-top, apply a glass ceramic cook-top conditioner which will protect the cook-top surface against any future stains, with a dry cloth or equivalent.

Stainless Steel Cleaning Instructions

Do not use abrasive pads; they will scratch the surface.

The basic rule of thumb is to use the mildest cleaning procedure that will do an effective job. Always rinse thoroughly with clear water and dry completely. Frequent cleaning will prolong the service life of stainless steel equipment and help maintain the finish. Ordinary deposits of waste and fluids can usually be removed with soap and water. More stubborn deposits or stuck on debris may require harder rubbing or the use of commercial cleaning products acceptable for use on metal surfaces. When using any cleansing agent, the rubbing should be in the direction of the polish lines or "grain" of the metal.

WARNING: steam cleaners must not be used.

KEEP THE PART OF THE HOB WHERE THE CONTROL SYMBOLS ARE SILK PRINTED ALWAYS PERFECTLY CLEAN.

Remove any adhesive film which protects some parts. Remove any residual glue carefully without using abrasive substances to avoid scratching the surfaces.

Servicing and technical problems

Before any servicing of the appliance for technical reasons it is necessary to disconnect the appliance from the MAINS. CONTACT A COMPETENT PERSON FOR THIS OPERATIONS!!!!

Warning : no alterations or adjustments should be made by unskilled and unauthorized persons to the appliance . Do not remove any parts from the appliance or substitute alternatives as this may affect the safety of the appliance and can be very dangerous and is not permitted.

In the event of a failure or breakdown of a unit itself, turn off the appliance and contact a competent person

Warning: it is recommended that this appliance is professionally serviced every year to verify if the appliance is in perfect condition and for servicing if necessary and in order to verify that the installation of the appliance still complies with the standards and regulations in practice.

A complete check-up of the whole installation has to be carried out punctually.

We stress the importance of obtaining expert advice regarding the installation of electric systems, temperatures and ventilation around the appliance.

WARNING

If the surface of the hob is cracked turn off the appliance and disconnect from the electrical main in order to avoid any possible electric shocks.

TURN OFF IMMEDIATELY THE APPLIANCE IF YOU SEE THAT THE GLASS IS BROKEN.

The appliance surface must be used only to cook not as support for objects of any type.

After using the hob for cooking, always turn off the appliance.

PAY ATTENTION AFTER USE THE APPLIANCE REMAINS VERY HOT. DO NOT TOUCH WITH BARE HANDS.

ACTIVATE THE SAFETY BLOCK if there are children or animals not far from the appliance.

Some parts of the appliance become particularly hot when in operation (hob's glass above all) do not touch with bare hands the mentioned parts when the appliance is operated and after use till all the parts cool down.

It is recommended that an oven glove is used when the appliance is being used since hot parts could be touched by accident. This appliance must be kept away from inflammable materials, and from heat sources of any kind.

This appliance and particularly the rear and bottom part must never be put in contact with plastic, wooden and inflammable objects and surfaces - do not use this appliance as a form of heating.

Adequate ventilation (according to the regulations of the country of destination) must be provided to ensure the appliance works in a safe manner.

The ventilation openings must be opened before starting to operate the appliance and then kept open while the appliance is being used.

The openings must not be blocked in any way.

Warning: the appliance must not be installed in areas subjected to strong draughts. Ventilation, mechanical or natural, should not interfere with appliance operation.

Do not spray aerosols in the vicinity of this appliance.

induction

induction hob

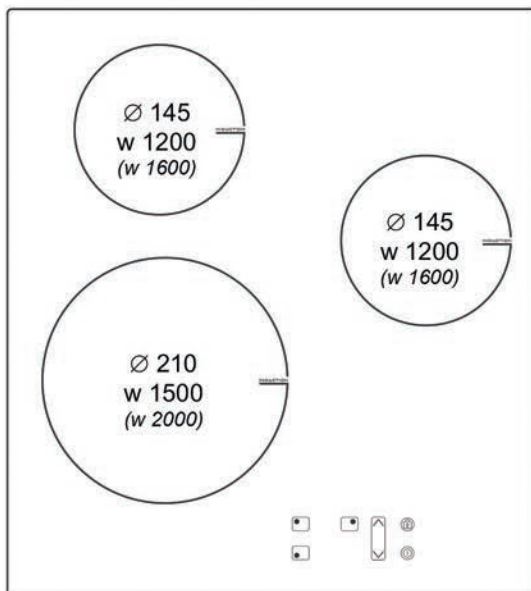

Assorbimento / Absorption / Anschlusswert : 5,2 kW

Fig. 5

H05V2V2/F - 2,5 mm²

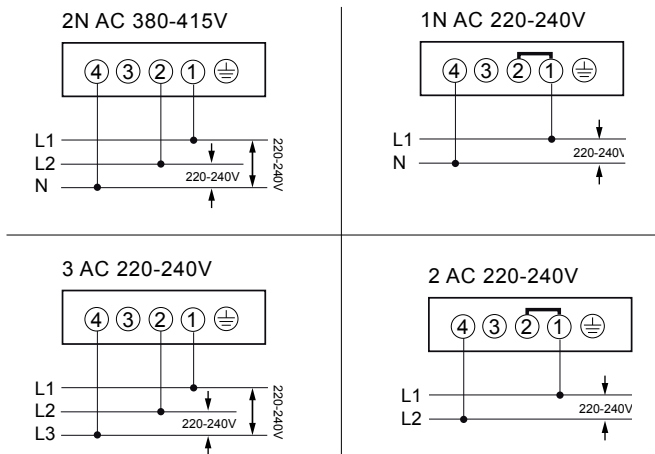

Fig. 6

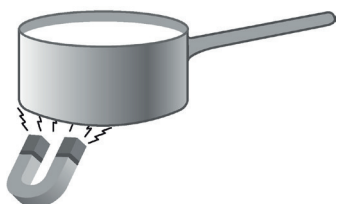

Fig. 7

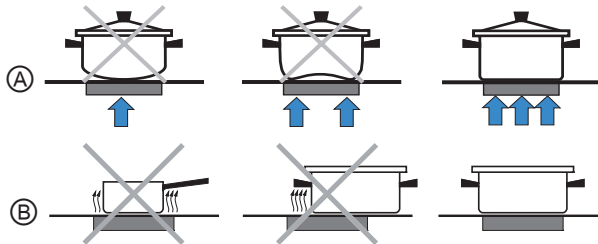

Fig. 8

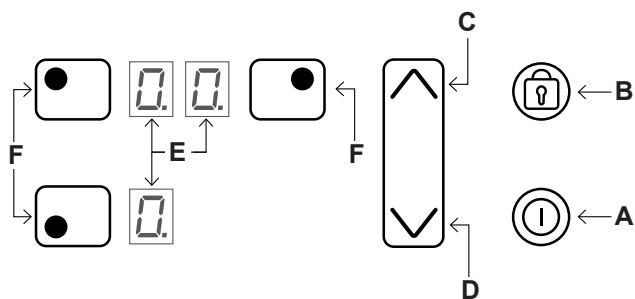
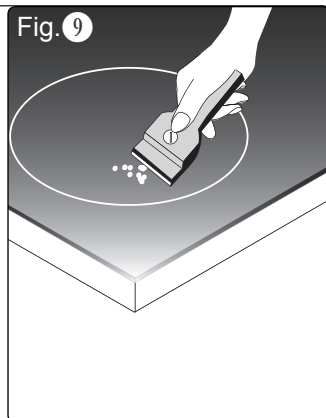

Fig. 9



Carefully read the contents of this leaflet since it provides important instructions regarding safety of installation, use and maintenance. Keep the leaflet for possible future consultation. All the operations relating to installation (electrical connections) must be carried out by specialised personnel in accordance with current regulations.

SAFETY WARNINGS

- Use the cooktop only in household-type situations for the preparation and warming of food. All other types of use are not permitted.
- Individuals who are incapable of using the appliance safely because of their physical, sensory or mental capabilities or their lack of experience or knowledge must not use this appliance without supervision or instruction by a responsible person.
- Children under 8 years of age must be kept away from the cooktop unless they are under constant supervision.
- Children 8 years and older must only be allowed to use the cooktop if they have been given supervision or instruction concerning use of the appliance in a safe way and understand the hazards involved.
- Children shall not play with the appliance.
- Cleaning and user maintenance shall not be made by children without supervision.
- Installation, repair and maintenance work should only be performed by an authorized service technician. Work by unqualified persons could be dangerous for the user.
- **RISK OF ELECTRIC SHOCK!** If the cooktop is defective or chipped, cracked or broken in any way, immediately switch it off and do not continue to use it. Disconnect it from the electrical power supply.
- **WARNING:** If the supply cord of the appliance is damaged, it must be replaced by the manufacturer, its service agent or similarly qualified persons in order to

avoid a hazard.

- **WARNING:** The appliance and its accessible parts become hot during use. Care should be taken to avoid touching heating elements.
- **WARNING:** Unattended cooking on a hob with fat or oil can be dangerous and may result in fire. NEVER try to extinguish a fire with water, but switch off the appliance and then cover flame e.g. with a lid or a fire blanket.
- **WARNING:** The cooktop is hot during use and remains so for some time after being switched off. The risk of burns remains until the residual heat indicators have gone out.
- **CAUTION:** The cooking process has to be supervised. A short term cooking process has to be supervised continuously.
- **DANGER OF FIRE:** Do not store items on the cooking surfaces! Metallic objects such as knives, forks, spoons and lids should not be placed on the hob surface since they can become hot.
- Always switch the cooking zones off after use!
- The appliance is not intended to be operated by means of an external timer or separate remote-control system.

INSTALLATION INSTRUCTIONS

These instructions are for a specialized installer and are a guide for the installation process, regulations and maintenance in accordance with the law and current standards.

If the built-in oven or any other appliances that produce heat, need to be installed directly underneath the cooking hobs in ceramic glass, **IT IS NECESSARY THAT THE APPLIANCE (oven) AND THE COOKING HOB IN CERAMIC GLASS ARE ADEQUATELY ISOLATED**, in such a way that the heat generated from the oven, measured on the right hand side of the bottom of the cooking hobs, does not exceed 60°C.

Failure to follow this precaution, could cause a malfunction in the TOUCH CONTROL system.

VENTILATION

The distance between the cooktop and built-in kitchen's furniture or cooking apparatuses must guarantee sufficient ventilation of the air. Not to use the cooktop if in the oven is in course the pyrolysis process.

ELECTRICAL CONNECTIONS (Fig.5)

Before making the electrical connections, check that:

- the system ratings meet the ratings indicated on the identification plate fixed on the lower part of the worktop;
- the system is fitted with efficient ground wires in accordance with the laws and current standards.

Grounding is mandatory by law.

If the domestic appliance is not supplied with a cable and/or suitable plug, use material suitable for the absorption value indicated on the identification plate and the operating temperature.

If wishing to make a direct connection to the mains, an omnipolar switch must be installed with a minimum 3 mm opening between the contacts and appropriate for the load indicated on the plate and in accordance with current standards (the yellow/green ground conductor must not be disconnected by a switch).

When the appliance has been installed, the omnipolar switch must be easily reachable.

USE AND MAINTENANCE

The fundamental characteristic of the induction system is the direct transference of heat from the generator to the cooking recipient.

Advantages:

- The transference of power takes place only when the recipient is placed on the cooking zone.
- The heat is generated only at the base of the recipient and transferred directly to the food to be cooked.
- Reduced heating time and low consumption of power during the beginning of cooking, allowing a global saving of power.
- The fibreglass top remains cold, the heat felt on the cooking top is that reflected from the base of the recipient.

COOKING RECIPIENTS

The use of appropriate recipients is an essential factor for induction cooking. Check that your pots are suitable for the induction system. **The recipients must contain iron.** You can check whether the material of the pot is magnetic with a simple magnet (Fig.6).

We advise recipients having a flat base (Fig.7A). This way you can use the power optimally.

Do not use recipients with a rough base to avoid scratching the thermal surface of the top.

- ° A very important factor in induction cooking is the dimension of the pot compared to the plate used (Fig.7B).

The cooking zones allow the use of recipients with bases of various diameters. It is, however, preferable to use the appropriate cooking zone for the dimension of the pot.

COOKING ZONE DIAMETER	MINIMUM PAN DIAMETER
Ø 145 mm	80 mm
Ø 210 mm	130 mm

USE (Fig.8)

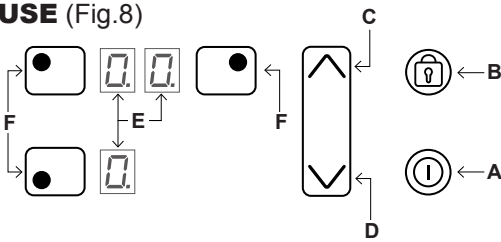

- A- ON/OFF key** > switch the appliance on and off
- B- Lock key** > activate control panel lock / child lock
- C- Plus key** > increase power level of the cooking zone
- D- Minus key** > reduce power level of the cooking zone
- E- Display area** > shows the values set for the cooking zone
- F- Cooking Zone** > select and activate the desired cooking zone



SWITCHING THE COOKING TOP ON

Press the on-off  key to switch the appliance on. The displays will turn on in the stand-by « . » position.

The control unit remains active for 10 seconds.

If no cooking zone is selected within this time, the cooking top switches off automatically.

SWITCHING THE COOKING AREA ON



Press the relative  key to select the desired cooking zone and press the  or  key within 10 seconds to set the power level.

The power of the single cooking zone can be adjusted in **9** different positions and will be shown on luminous display B with a number from “1 to 9”.

QUICK / BOOSTER HEATING «P»

This function further reduces cooking time in a given area taking the temperature to the maximum power for a 10 minute interval. At the end of this interval, the cooking area power automatically returns to level 9.

The use of this function is recommended

for heating a large quantity of liquid in a very short time (i.e. water for cooking pasta) or other dishes. To activate this function, select the cooking area and press the key  up to level 9. Press the  key again. An acoustic signal will be emitted and a symbol «P» will be visualised on the display E relative to the area.

RESIDUAL HEAT «H»

If the temperature of the cooking area is still high (over 50°) after it has been switched off, the relative display will indicate the «H» symbol (residual heat). The symbol will only switch off when the burn risk is no longer present.

POT DETECTION «L»

If the symbol «L» should appear on one of the cooking area displays, it means that:

- 1)** The recipient being used is not suitable for induction cooking.
- 2)** The diameter of the recipient used is inferior to that allowed by the appliance.
- 3)** No recipient is present.

TIMER «t»

This function allows you to set the time (from «01» to «99» minutes) to automatically switch off of the selected cooking zone.

Select a cooking zone by pressing one of the **F** keys and set the power by pressing the **C** or **D** keys.



To activate the timer press again the **F** key, an acoustic signal will be heard and the «t» symbol will appear on the display of the selected cooking zone.

Set the time by pressing the **C** or **D** keys. If the cooking zone is in the lower part of the cooktop the time will be shown on the display of the cooking zone in the upper part of the cooktop and vice versa. Press the key **F** again to confirm your selection.





When the timer function elapses, the cooking zone will automatically switch off and an acoustic signal will be heard.

To disable the timer function, press the **F** key on the cooking zone previously started, bring the timer value back to «00» by using the **D** key, then press the **B** key again to confirm your selection.

CONTROL PANEL LOCK

The  key blocks the hob functioning, in order to prevent any unintentional operation (e.g. by children). In this state no action on the keys has effect. To activate the safety function, press the  key until the warning light switches on. The cooking top can however be switched off even when the controls block is activated. In this case the controls block remains active when the top is switched on again. To deactivate the safety function press the  key until the warning light switches off.

SWITCHING OFF THE COOKING ZONES

To switch a cooking zone off, press the relative  key to select it then press simultaneously the  and  key, or press the  key until reaching position .

SWITCHING THE COOKING TOP OFF

To turn off the cooking top entirely hold down the  key.

SAFETY SWITCH

The appliance has a safety switch that automatically switches off the cooking zones when they have been operating for a certain amount of time at a given power level.

POWER LEVEL	OPERATING TIME LIMIT (hours)
1 - 8	10
9	3

MAINTENANCE

Remove any residues of food and drops of grease from the cooking surface by using the special scraper supplied on request (Fig.9).

Clean the heated area as thoroughly as possible using suitable products, and a cloth/paper, then rinse with water and dry with a clean cloth.

Using the special scraper immediately remove any fragments of aluminium and

plastic material that have unintentionally melted on the heated cooking area, or residues of sugar or food with a high sugar content.

In this way, any damage to the cooktop surface can be prevented. Under no circumstances should abrasive sponges, or corrosive chemical detergents, such as oven sprays or stain removers, be used.

WARNING: STEAM CLEANERS MUST NOT BE USED.

DISPOSAL OF OLD ELECTRICAL APPLIANCES



The European Directive 2002/96/EC on Waste Electrical and Electronic Equipment (WEEE), requires that old household electrical appliances must not be disposed of in the normal unsorted municipal waste stream. Old appliances must be collected separately in order to optimise the recovery and recycling of the materials they contain and reduce the impact on human health and the environment. The crossed-out dustbin symbol on the product reminds you of your obligation regarding separated waste collection. Consumers should contact their local public service or their local dealer for more information on the correct disposal of exhausted household appliances.

THE MANUFACTURER DECLINES ALL RESPONSIBILITY FOR EVENTUAL DAMAGES CAUSED BY BREAKING THE ABOVE WARNINGS.

THE WARRANTY IS NOT VALID IN THE CASE OF DAMAGE CAUSED BY FAILURE TO COMPLY WITH THE ABOVE WARNINGS.

Displaying Special Statuses

The corresponding heater display alternates between two characters depending on the status.

Event	Heater status	Start conditions	End conditions	Action	Heater Display fore (1 sec.)	Heater Display back (1 sec.)	Priority
Heater with residual heat	Off	Heater Temperature > 50°C	Heater Temperature < 40°C	-----	'H'	'H'	3
Heater without pan	On	No pan or not suitable pan over the heater	Heater Off	In 1 minute Heater off	'Power'	'u'	1
Induction generator over temperature	Off	Heat sink Temperature > 90°C	Heat sink Temperature < 80°C	-----	' ' or 'H'	'c'	2
Induction generator over temperature	On			No power is delivered to the heater	'Power'		

Errors/Alarms

The corresponding heater display alternates between two characters depending on the Error.

APPLIANCE ERRORS				
Event (Visualization Priority Order)	Description	Action	End	All Heater Displays (fore 0.5 sec./ back 0.5 sec)
FalloKeyOnOffEmitter	Security Key Error	App Off (*)	-----	FA
FalloKeyOnOffReceiver	Security Key Error	App Off (*)	-----	FC
FalloNtcShort	Touch NTc Error	App Off (*)	-----	FE
FalloNtcOpen	Touch NTc Error	App Off (*)	-----	FP
FalloOverTemp	Touch NTc Error	App Off (*)	T < 90°C	Fc
FalloEepromChecksum	Eeprom Checksum Error	App Off (*)	-----	FH
FalloAdc	Security Key Error	App Off (*)	-----	FJ
FalloSw	Software Error	App Off (*)	-----	F0
FalloAmbientLight	Keyboard Error	App Off (*)	Light Condition	FL
FalloDivisor	Security Key Error	App Off (*)	-----	FU
FalloTestLedOnOff	OnOff Led Error	App Off (*)	-----	Fd
FalloTetGroupSelection	Keyboard Error	App Off (*)	-----	Fb

(*) All heaters switched Off and locked

HEATER ERRORS				
Event (Visualization Priority Order)	Description	Action	End	Heater Display (fore 0.5 sec./ back 0.5 sec)
FalloComunicaciones	Communication Error	Induction Heaters Off(**)	Comm. OK	F5
FalloNtcFocoShort	Induction Heater Ntc Error	Heater Off(**)	Serial Comm.	F1
FalloNtcFocoOpen	Induction Heater Ntc Error	Heater Off(**)	Serial Comm.	F2
FalloNtcFoco	Induction Heater Ntc Error	Heater Off(**)	Serial Comm.	F7
FalloNtcGeneradorShort	Induction Ntc Error	Generator Off (***)	Serial Comm.	F3
FalloNtcGeneradorOpen	Induction Ntc Error	Generator Off (***)	Serial Comm.	F4
FalloNtcGenerador	Induction Ntc Error	Generator Off (***)	Serial Comm.	F8
FalloNoRedGenerador	Induction Error	Generator Off (***)	Serial Comm.	F6
FalloOverLoadGenerador	Induction Error	Generator Off (***)	Serial Comm.	F9

(**) Heater switched off and locked

(***) Generator Heaters switched off and locked

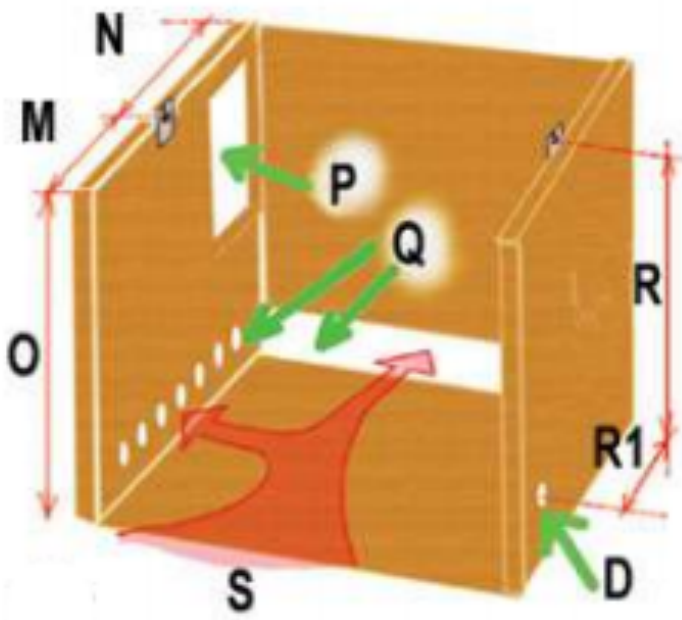

ELECTRIC TERMINAL

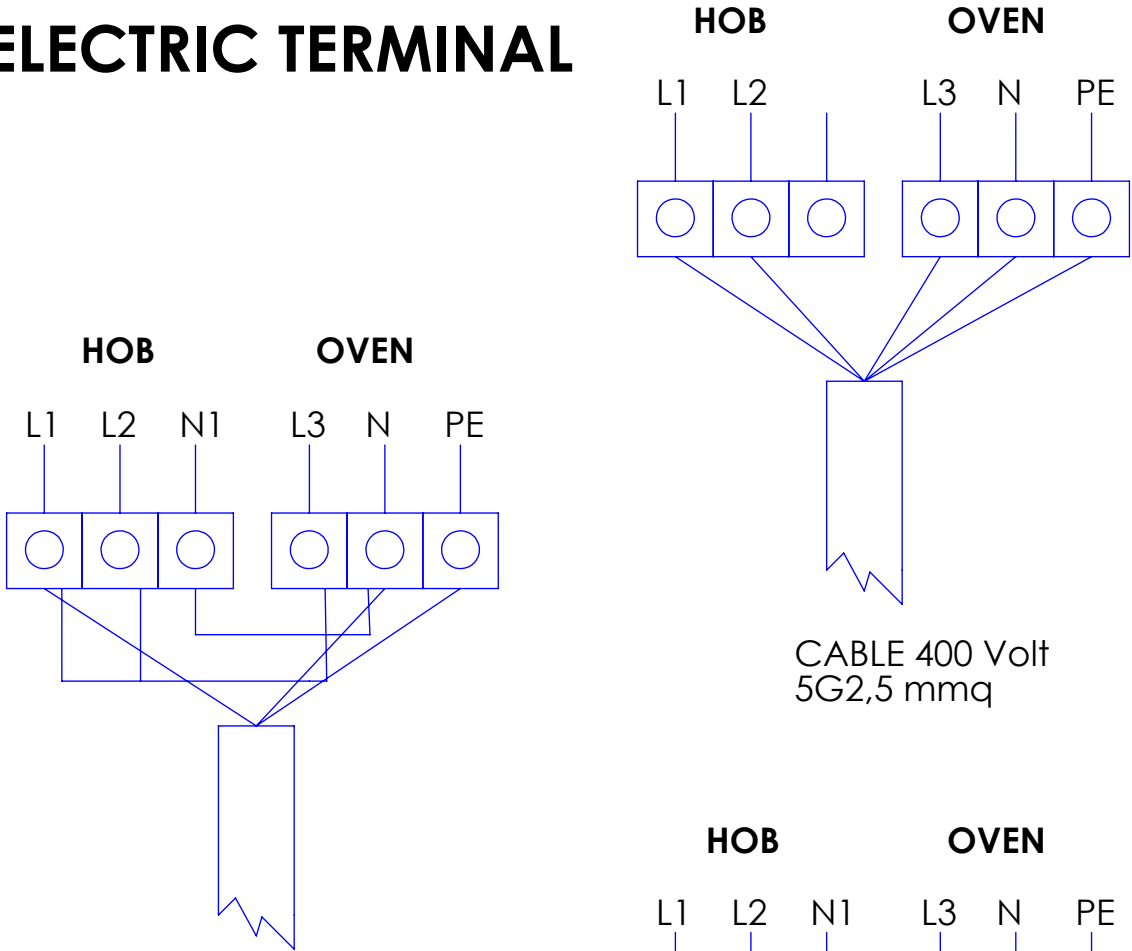

CABLE 400 Volt
5G2,5 mmq

CABLE 230 Volt
3G6 mmq

CABLE 230 Volt
3G4 mmq

CABLE 230 Volt
3G2,5 mmq

SE NON SPECIFICATO: QUOTE IN MILLIMETRI FINITURA SUPERFICIE: TOLLERANZE: LINEARE: ANGOLARE:		FINITURA:		INTERRUZIONE BORDI NETTI		NON SCALARE DISEGNO		REVISIONE	
NOME		FIRMA		DATA		TITOLO:			
DISEG.		VERIF.		APPR.		N. DISEGNO			
FABB.		Qual.		MATERIALE:		400V-230V		A4	
PESO:		SCALA:1:1		FOGLIO 1 DI 1					

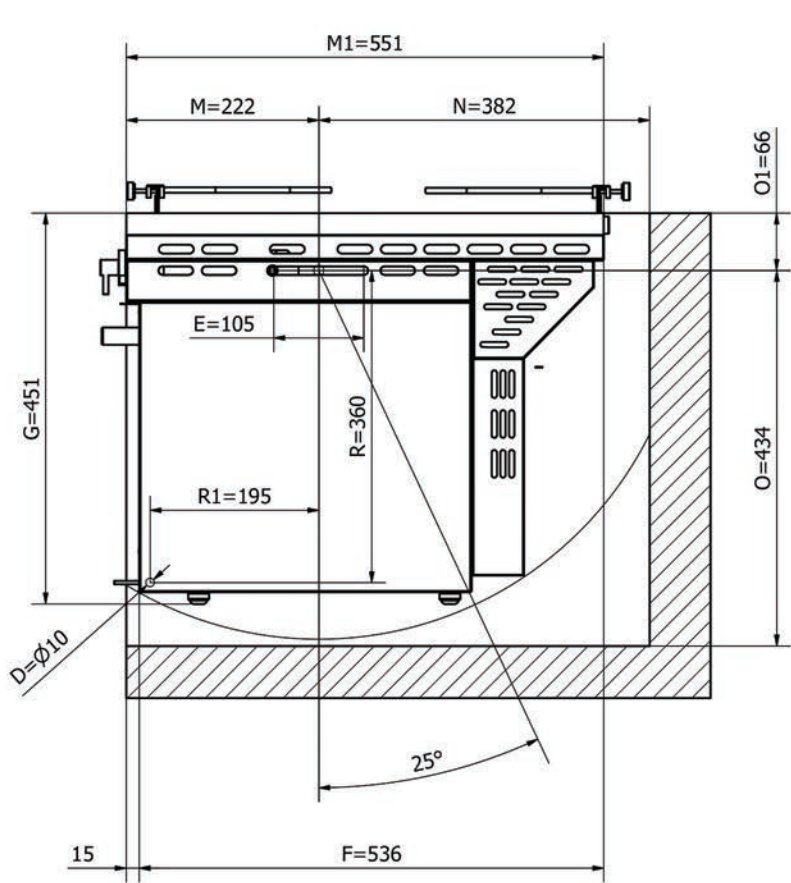

B-B (1:5)

